



We Focus · We Deliver

# VoIP Phone **HD**<sup>iii</sup> CooFone-D30/D30P

Quick Installation Guide



**Smart VoIP**

[www.zycoo.com](http://www.zycoo.com)

---

## Table of Contents

1 Instruction .....	02
2 The Appearance of Product .....	03
3 Connecting IP Phone .....	04
4 IP Phone Setup Menu .....	05
4.1 Network mode Settings diagram .....	05
4.2 The menu of phone Structure .....	06
5 Configuration .....	07
5.1 Web Login .....	07
5.2 Network-PPPoE Setting .....	08
5.3 Network-Static Setting .....	08
5.4 Network-DHCP Setting .....	09
5.5 SIP Settings .....	09
6 Make a Phone Call .....	10
6.1 IP Address .....	10
6.2 SIP Number .....	10

# 1 Instruction

This phone can be setted through the LCD or web page.  
If you own this product to make some VoIP calls,an Ethernet-based Cable or a DSL modem with an active connection to the Internet are necessary.

## Check Your Package Contents

These are the items included with your D30/D30P IP Phone purchase:



VoIP Phone D30/D30P



Handset



Power adaptor



Handset cord



Quick Installation Guide



Ethernet Cable

## 2 The Appearance of Product

Front view and keypad function:

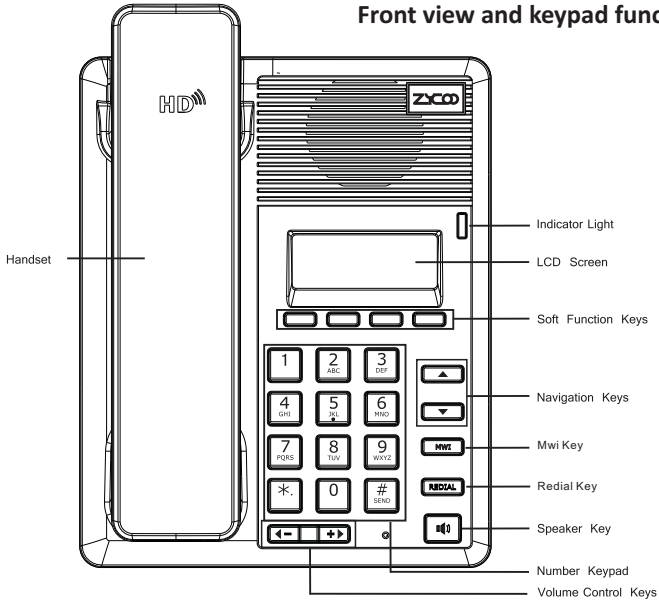

You can press these number keys one or more times to complete the corresponding input when you want do some input on the LCD.

Key	Text Mode		Key	Text Mode	
	Normal(ABC)	Numeric(0-9)		Normal(ABC)	Numeric(0-9)
1		1	7 PQRS	PQRSpqrs	7
2 ABC	ABCabc	2	8 TUV	TUVtuv	8
3 DEF	DEFdef	3	9 WXYZ	WXYZwxyz	9
4 GHI	GHIghi	4	0		0
5 JKL	JKLjkl	5	*	#@.,:;\$%& ( )<>[]~!_=-?~	*
6 MNO	MNOmno	6	# SEND		#

### 3 Connecting IP Phone

Connect the IP Phone as shown by the following diagram:

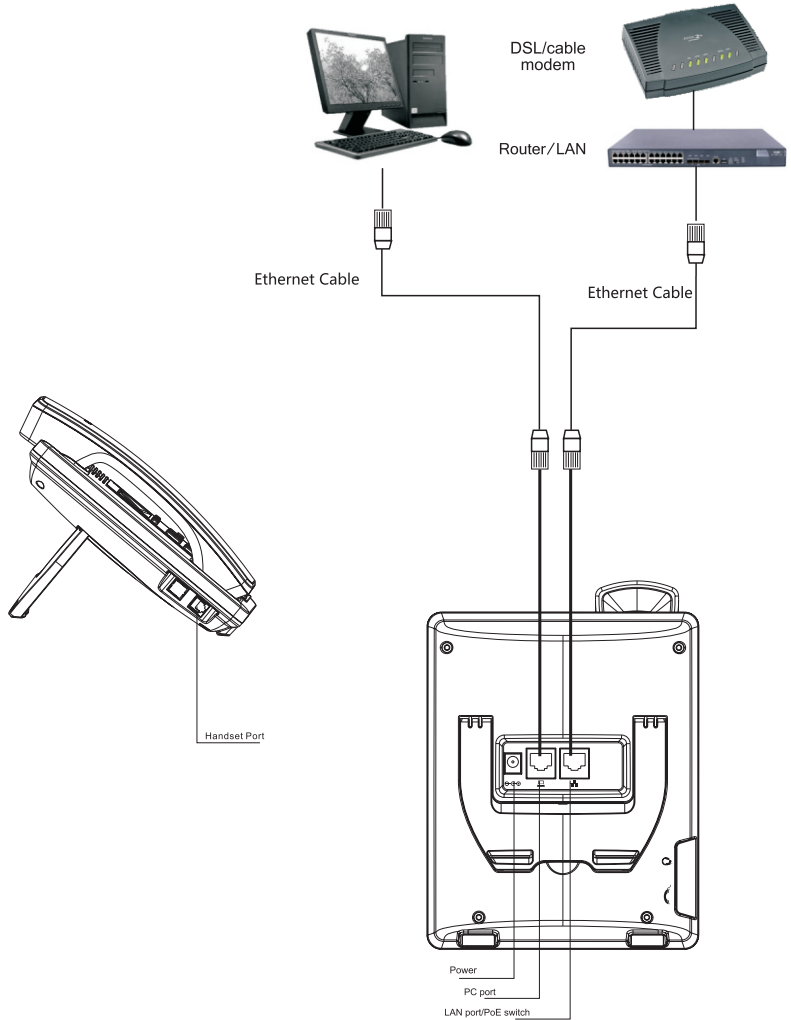

## 4 IP Phone Setup Menu

### 4.1 Network mode Settings diagram:

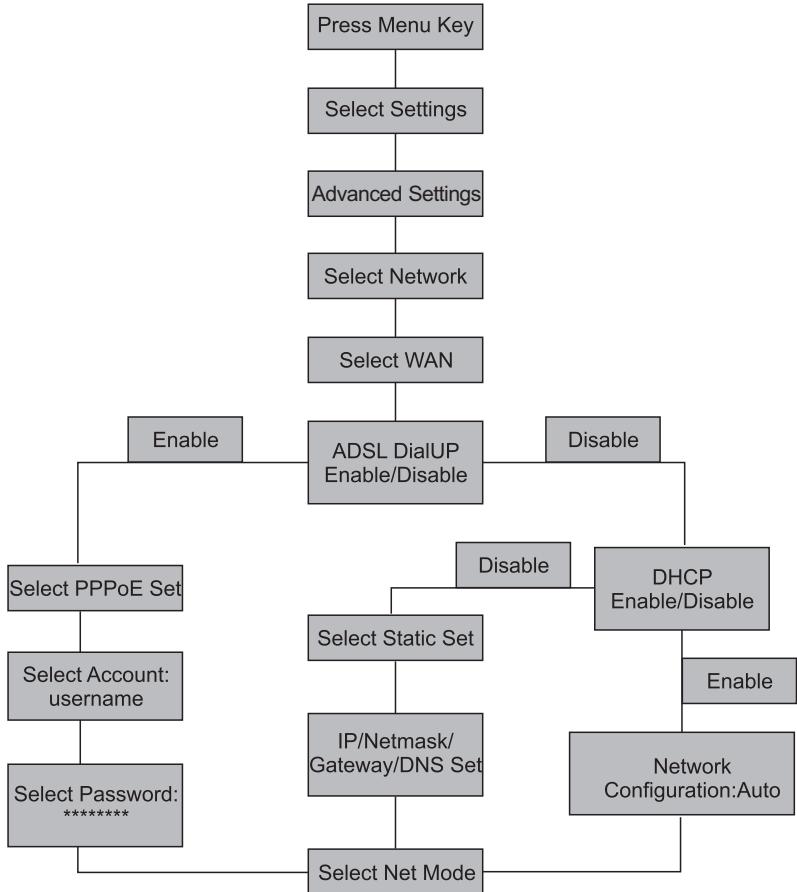

4.2 The menu of phone Structure:

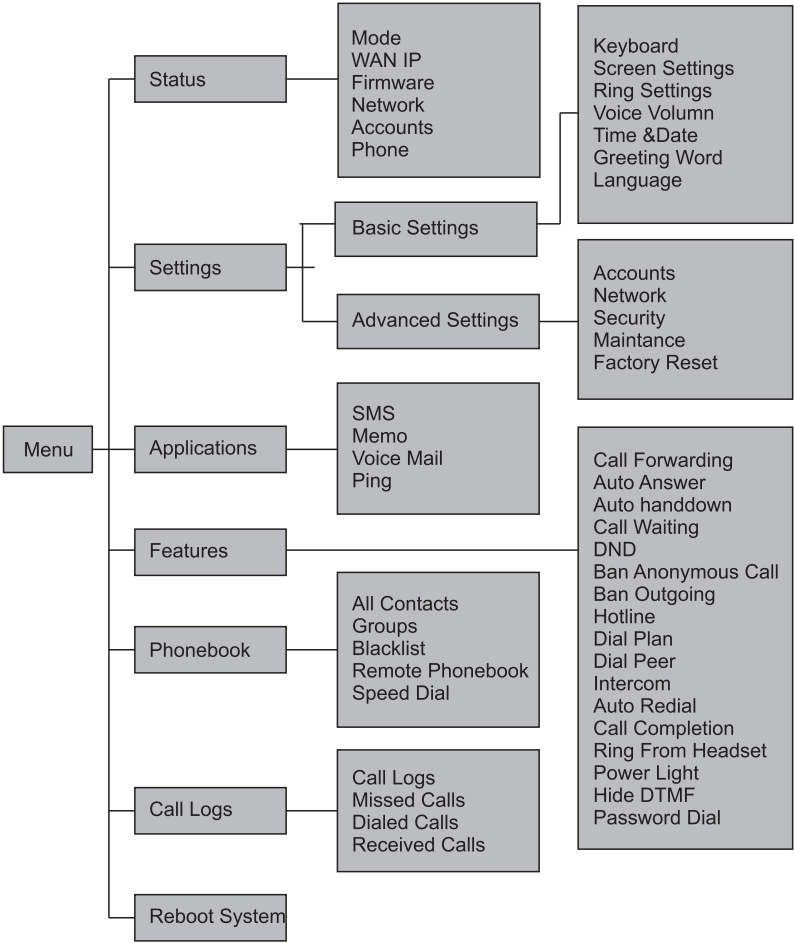

## 5 Configuration

### 5.1 Web Login

The configuration menu of D30/D30P can be accessed using the convenient and user-friendly interface of a web browser.



Open the browser and type into the IP address which can be found in the status of the LCD menu(e.g.http://192.168.1.16)to visit the Web page and make some configuration.

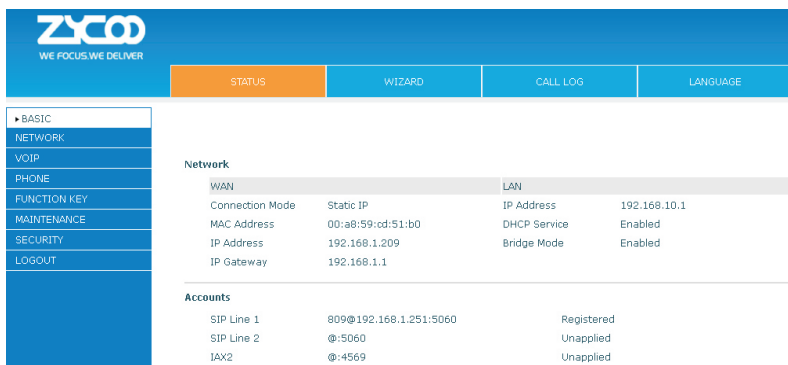

Enter the username and password,and both of the default username and password are"admin". After your logon,the Web page will be displayed as follows.

A screenshot of the ZYCO configuration web interface. The top header is blue with the ZYCO logo and tagline. Below the header is a navigation bar with four tabs: "STATUS" (highlighted in orange), "WIZARD", "CALL LOG", and "LANGUAGE". On the left side, there is a vertical menu with the following items: "BASIC", "NETWORK", "VOIP", "PHONE", "FUNCTION KEY", "MAINTENANCE", "SECURITY", and "LOGOUT". The main content area is titled "Network" and contains a table with columns for WAN and LAN. Below the Network table is a section titled "Accounts" with a table listing SIP Line 1, SIP Line 2, and IAX2 configurations.

WAN		LAN	
Connection Mode	Static IP	IP Address	192.168.10.1
MAC Address	00:a8:59:cd:51:b0	DHCP Service	Enabled
IP Address	192.168.1.209	Bridge Mode	Enabled
IP Gateway	192.168.1.1		

  

Accounts		
SIP Line 1	809@192.168.1.251:5060	Registered
SIP Line 2	@:5060	Unapplied
IAX2	@:4569	Unapplied

## 5.2 Network-PPPoE Setting

Select Network from the main menu.

Select PPPoE as network connection type if your ISP uses PPPoE. (Most DSL users use PPPoE)



WE FOCUS WE DELIVER

WAN LAN QoS&VLAN SERVICE PORT DHCP SERVICE TIME&DATE

- BASIC
- ▶ NETWORK
- VOIP
- PHONE
- FUNCTION KEY
- MAINTENANCE
- SECURITY
- LOGOUT

**WAN Status**

Active IP Address	192.168.1.209
Current Subnet Mask	255.255.255.0
Current IP Gateway	192.168.1.1
MAC Address	00:a8:59:cd:51:b0
MAC Timestamp	20130611

**WAN Settings**

Obtain DNS Server Automatically  Enabled

Static IP  DHCP  PPPoE

Service Name

User

Password

## 5.3 Network-Static Setting

Select Static as network connection type if all Wide Area Network IP is provided to you by your ISP.



WE FOCUS WE DELIVER

WAN LAN QoS&VLAN SERVICE PORT DHCP SERVICE TIME&DATE

- BASIC
- ▶ NETWORK
- VOIP
- PHONE
- FUNCTION KEY
- MAINTENANCE
- SECURITY
- LOGOUT

**WAN Status**

Active IP Address	192.168.1.209
Current Subnet Mask	255.255.255.0
Current IP Gateway	192.168.1.1
MAC Address	00:a8:59:cd:51:b0
MAC Timestamp	20130611

**WAN Settings**

Static IP  DHCP  PPPoE

IP Address

Subnet Mask

IP Gateway

DNS Domain

Primary DNS

Secondary DNS

## 5.4 Network-DHCP Setting

Select DHCP as network connection type if your access network supports DHCP.

The screenshot shows the Zyco network configuration interface. The top navigation bar includes tabs for WAN, LAN, QoS/VLAN, SERVICE PORT, DHCP SERVICE, and TIME/DATE. The left sidebar contains menu items: BASIC, NETWORK, VOIP, PHONE, FUNCTION KEY, MAINTENANCE, SECURITY, and LOGOUT. The main content area is titled 'WAN Status' and displays the following information:

Active IP Address	192.168.1.209
Current Subnet Mask	255.255.255.0
Current IP Gateway	192.168.1.1
MAC Address	00:a8:59:cd:51:b0
MAC Timestamp	20130611

Below this is the 'WAN Settings' section:

Obtain DNS Server Automatically	<input type="button" value="Enabled"/>
Enable Vendor Identifier	<input type="button" value="Disabled"/>
Vendor Identifier	<input type="text" value="CooFone D30"/>
Static IP	<input type="radio"/>
DHCP	<input checked="" type="radio"/>
PPPoE	<input type="radio"/>

An 'Apply' button is located below the WAN Settings section. The '802.1X Settings' section is also visible, with fields for User (admin) and Password (masked with asterisks).

## 5.5 SIP Settings

Select SIP settings from the main menu. The following fields such as Server Address, Server Port, Authentication User, Authentication Password and SIP User are required. Then check Enable Registration and click Apply to register your phone to the SIP server.

The screenshot shows the Zyco network configuration interface for SIP settings. The top navigation bar includes tabs for SIP, IAX2, STUN, DIAL PEER, and MCAST. The left sidebar contains menu items: BASIC, NETWORK, VOIP, PHONE, FUNCTION KEY, MAINTENANCE, SECURITY, and LOGOUT. The main content area is titled 'SIP Line' and displays the following information:

SIP Line: SIP 1

Basic Settings >>

Status	Registered	Domain Realm	<input type="text"/>
Server Address	<input type="text" value="192.168.1.251"/>	Proxy Server Address	<input type="text"/>
Server Port	<input type="text" value="5060"/>	Proxy Server Port	<input type="text"/>
Authentication User	<input type="text" value="809"/>	Proxy User	<input type="text"/>
Authentication Password	<input type="text" value="*****"/>	Proxy Password	<input type="text"/>
SIP User	<input type="text" value="809"/>	Backup Proxy Server Address	<input type="text"/>
Display Name	<input type="text"/>	Backup Proxy Server Port	<input type="text" value="5060"/>
Enable Registration	<input checked="" type="checkbox"/>	Server Name	<input type="text"/>

Below this are sections for 'Codecs Settings >>' and 'Advanced SIP Settings >>'. An 'Apply' button is located at the bottom right of the form.

Server Address  
Server Port  
Authentication User  
Authentication Password

SIP user  
SIP server address  
SIP server port number

Username for logging into the SIP server  
Password for logging into the SIP server  
SIP phone number

---

## 6 Make a Phone Call

### 6.1 IP Address:

- 1.Lift the handset or press the speaker button or headset button to enter the dialer interface.
- 2.Dial IP address.

For example:Input#192.168.0.1# in the dialer interface,you will call the device whose IP address is 192.168.0.1.

### 6.2 SIP Number:

Note:You have to register with SIP server to use SIP number.

- 1.Lift the handser or press the speaker button or headset button to enter the dialer interface.
- 2.Dial SIP number.

For example:Input 1866

- 3.Press"#”button or wait until the timer expires.

The logo for ZYCOO, featuring the letters Z, Y, C, O, and O in a bold, stylized, sans-serif font. The letters are interconnected, with the 'Y' and 'C' sharing a vertical stroke, and the two 'O's sharing a horizontal stroke at the top. The 'Z' is positioned to the left of the 'Y' and 'C'.

We Focus · We Deliver